



# HyQvia

[Immune Globulin Infusion 10% (Human)  
with Recombinant Human Hyaluronidase]

## How to Infuse HYQVIA With a Syringe Driver Pump

### Your Step-by-Step Guide

*This guide is intended for use only as a supplement to in-person training from your healthcare professional.*

#### What is HYQVIA?

HYQVIA is a liquid medicine that is given under the skin (subcutaneously) to treat primary immunodeficiency (PI) in people 2 years and older.

#### Important Safety Information

##### What is the most important information that I should know about HYQVIA?

- HYQVIA can cause blood clots.
- Call your healthcare professional (HCP) if you have pain, swelling, warmth, redness, or a lump in your legs or arms, other than at the infusion site(s), unexplained shortness of breath, chest pain or discomfort that worsens on deep breathing, unexplained rapid pulse, numbness or weakness on one side of the body.
- Your HCP may perform blood tests regularly to check your IgG level.
- Do not infuse HYQVIA into or around an infected or red swollen area because it can cause infection to spread.

Please scroll for additional Important Safety Information, and click for [Information for Patients](#), and discuss with your healthcare provider.





*HyQvia*

[Immune Globulin Infusion 10% (Human)  
with Recombinant Human Hyaluronidase]



[Immune Globulin Infusion 10% (Human)  
with Recombinant Human Hyaluronidase]

## THE 5 STAGES TO INFUSE HYQVIA

### 1 GET READY

- Inspect vials
- Gather supplies
- Wash hands

### 2 PREPARE THE HY

- Draw HY into syringe(s)
- Attach to needle set
- Fill needle set

### 3 PREPARE THE IG

- Draw IG into syringe(s)

### 4 INFUSE HYQVIA

- Insert and secure needle(s)
- Infuse HY manually (first)
- Infuse IG with pump (second)

### 5 FINISH UP

- Remove needle(s)
- Log infusion

## Infusion Overview

This guide is designed to help you infuse HYQVIA [Immune Globulin Infusion 10% (Human) with Recombinant Human Hyaluronidase] Solution using a syringe driver pump, but is not meant as stand-alone instructions. Please refer to your Information for Patients for a complete list of steps.

**Infuse HYQVIA only after you have been trained by your healthcare professional, have the Information for Patients, and are comfortable that you can perform all the steps on your own.**

### Important Safety Information (continued)

#### Who should not take HYQVIA?

Do not take HYQVIA if you:

- Are allergic to IgG, hyaluronidase, other blood products, or any ingredient in HYQVIA.

**Please scroll for additional Important Safety Information, and click for [Information for Patients](#), including [Warning about Blood Clots](#), and discuss with your healthcare provider.**

HyQvia = HY + IG

HY 1st

IG 2nd

HY=Recombinant Human Hyaluronidase.  
IG=Immune Globulin Infusion 10% (Human).



If you have any questions about your HYQVIA infusion, contact a Nurse Advocate at **1-855-250-5111**.



**HyQvia**

[Immune Globulin Infusion 10% (Human)  
with Recombinant Human Hyaluronidase]



[Immune Globulin Infusion 10% (Human)  
with Recombinant Human Hyaluronidase]

## WHAT YOU'LL NEED

Below are the supplies you will need to infuse HYQVIA [Immune Globulin Infusion 10% (Human) with Recombinant Human Hyaluronidase] Solution. The supplies you receive from your pharmacy may look different.



| HYQVIA vial(s)



| Alcohol swabs, antibacterial cleaner, soap, tape, and bandages. Gloves can be used if recommended by your healthcare professional

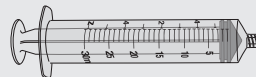

| 20 mL or 30 mL syringe(s)



| Sterile tip caps—1 per syringe

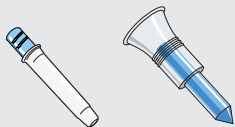

| Needle or needle-less transfer device\*—1 per HY vial

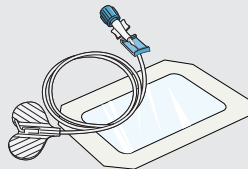

| Subcutaneous needle set with a clear dressing—1 per infusion site

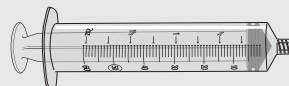

| 60 mL syringe(s)

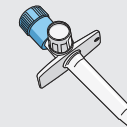

| Vented spike(s)



| Syringe driver pump, power supply, and manual



| Sharps container and trash can



| Infusion log

\*Use an 18-22 gauge sterile needle to draw from the 1.25 mL vial of HY.



**HyQvia**

[Immune Globulin Infusion 10% (Human)  
with Recombinant Human Hyaluronidase]



[Immune Globulin Infusion 10% (Human)  
with Recombinant Human Hyaluronidase]

# ADMINISTRATION AT A GLANCE

## Prepare

- Transfer HY into syringe(s) (first)
- Transfer IG into syringe(s) (second)

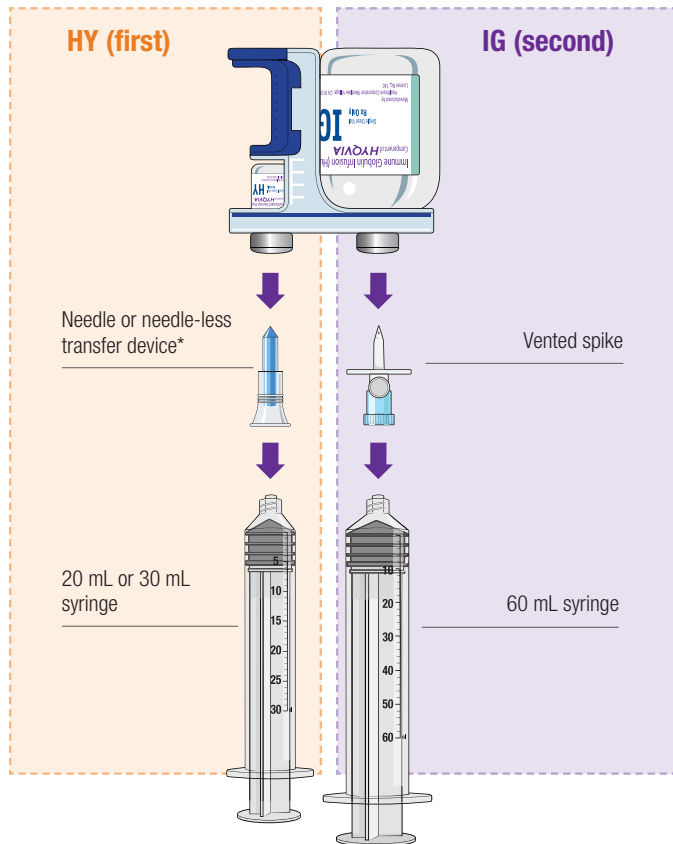

## Infuse†

- Infuse HY manually (first)
- Infuse IG using syringe driver pump (second)

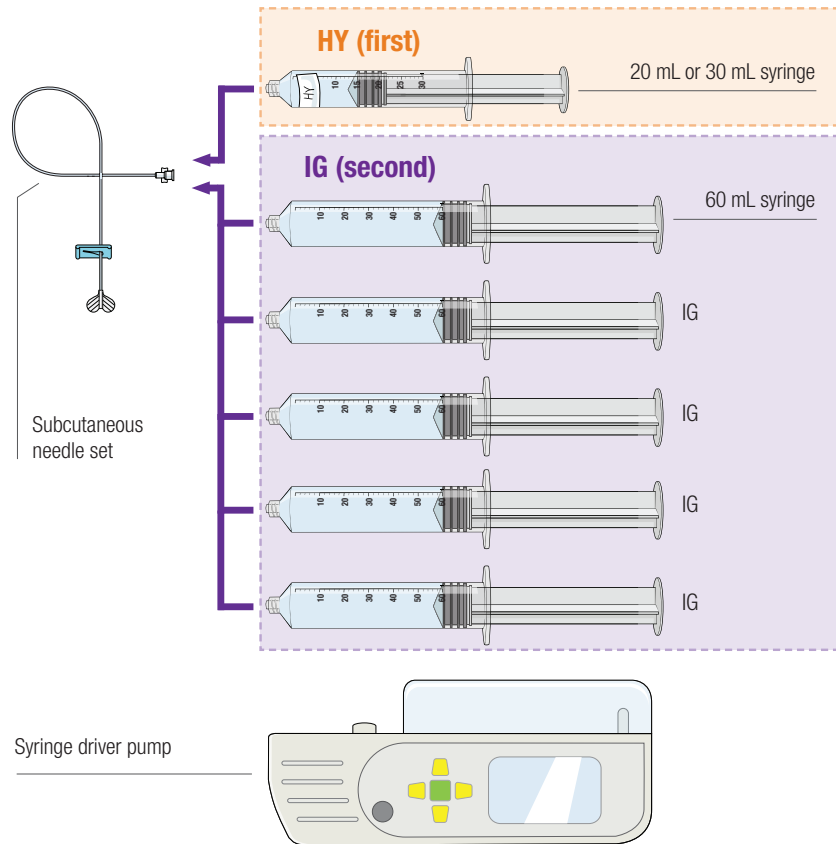

\*Use an 18-22 gauge sterile needle to draw from the 1.25 mL vial of HY.

†The number of syringes required is dependent on your prescribed dose. This diagram is an example.

# STAGE 1

## Get Ready

- Inspect vials
- Gather supplies
- Wash hands

### Important Safety Information (continued)

#### What should I avoid while taking HYQVIA?

- HYQVIA can make vaccines (like measles/mumps/rubella or chickenpox vaccines) not work as well for you. Before you get any vaccines, tell your HCP that you take HYQVIA.

***Please scroll for additional Important Safety Information, and click for [Information for Patients](#), including Warning about Blood Clots, and discuss with your healthcare provider.***

**HyQvia**  
[Immune Globulin Infusion 10% (Human)  
with Recombinant Human Hyaluronidase]



# HyQvia

[Immune Globulin Infusion 10% (Human)  
with Recombinant Human Hyaluronidase]



- Take HYQVIA out of the box and allow to reach room temperature. This may take up to 60 minutes. Do not apply heat or place in the microwave.
- Do not return HYQVIA back to the refrigerator if you take it out to room temperature.\*
- Do not shake HYQVIA.
- Do not use HYQVIA after the expiration date.
- Do not use HYQVIA if the vials are missing a protective cap, or are broken.
- Check the vials for color—the HY should be clear and colorless and the IG should be clear and colorless or pale yellow. Do not use HYQVIA if the liquid is cloudy or contains particles.

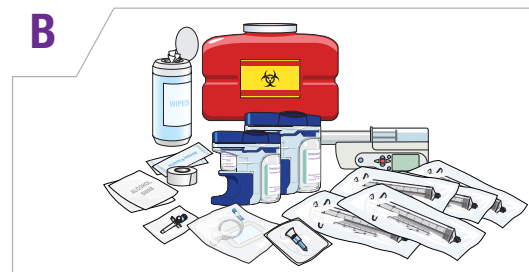

I Gather your supplies.

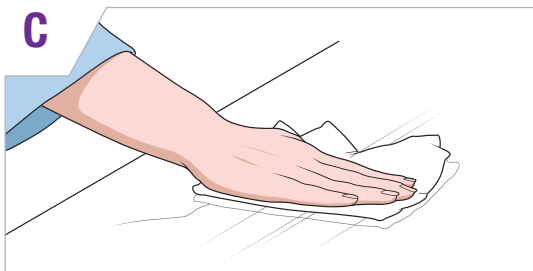

I Clean your work area with an antibacterial cleaner. If you have an infusion mat or antibacterial towel, lay it out.



I Wash your hands with antibacterial soap. If instructed by your healthcare professional, put gloves on when your hands are dry.



I Open your supplies. Keep them in their packages and place near the clean work area.

\*HYQVIA can be stored in the refrigerator (36°F-46°F [2°C-8°C]) for up to 36 months, or at room temperature (up to 77°F [25°C]) for up to 3 months during the first 24 months from the date of manufacturing. Do not freeze HYQVIA. To protect from light, store HYQVIA in its original box.

You're ready for **Stage 2!** >>>

1 GET READY

2 PREPARE HY

3 PREPARE IG

4 INFUSE HYQVIA

5 FINISH UP

# STAGE 2

## Prepare the HY

- Draw HY into syringe(s)
- Attach to needle set
- Fill needle set



### Important Safety Information (continued)

#### What should I tell my HCP before I start using or while using HYQVIA?

Tell your HCP if you:

- Have or had any kidney, liver, or heart problems or history of blood clots because HYQVIA can make these problems worse.
- Have IgA deficiency or a history of severe allergic reactions to IgG or other blood products.
- Are pregnant, trying to become pregnant or are breast feeding. It is not known whether HYQVIA can harm the unborn baby or breastfed infant.

*Please scroll for additional Important Safety Information, and click for [Information for Patients](#), including [Warning about Blood Clots](#), and discuss with your healthcare provider.*

**HyQvia**

[Immune Globulin Infusion 10% (Human)  
with Recombinant Human Hyaluronidase]

# HyQvia

[Immune Globulin Infusion 10% (Human)  
with Recombinant Human Hyaluronidase]



Take the cap off of the dual-vial unit(s). Without shaking the vials, clean each vial of HY by wiping the stopper with an alcohol swab and let it dry. Prepare a label for the HY syringe and set it aside.

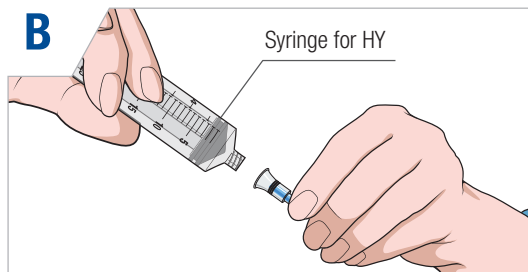

Remove a 20 mL or 30 mL sterile syringe from the package. Attach a needle/needle-less transfer device\* to the syringe. Pull back on the plunger to fill the syringe with air (the amount of air should equal the amount of HY in the vial). Remove the cap from the needle/needle-less transfer device.

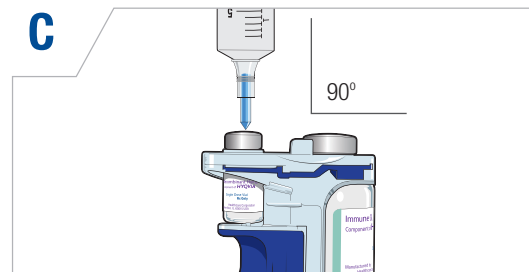

Insert the needle/needle-less transfer device into the center of the HY vial stopper at a 90-degree angle. Push the air into the vial.

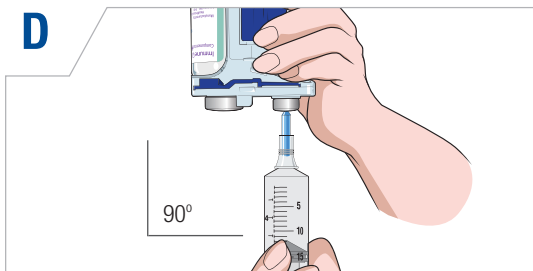

Turn the vial upside down. Pull back on the plunger to withdraw the full amount of HY. Remove the needle/needle-less transfer device from the HY vial. Re-cap the needle/needle-less transfer device.† Remove it from the HY syringe and discard it in the sharps container. Repeat steps C and D for each HY vial, using the same syringe, if possible.

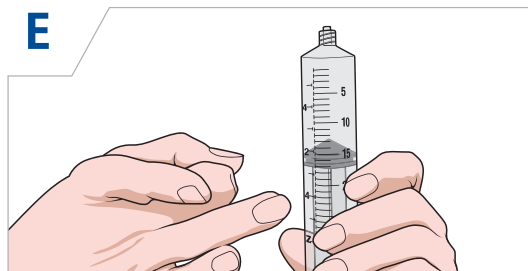

When the full dose of HY has been transferred into the syringe, hold the syringe upright and tap it to remove air bubbles. Then slowly push the plunger until the HY reaches the tip of the barrel.

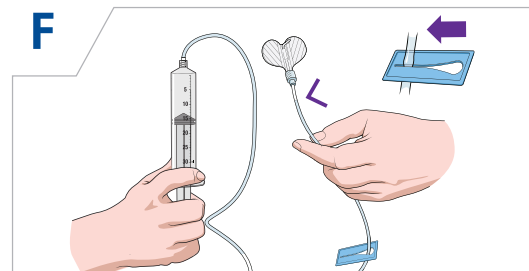

Remove the cap from the subcutaneous needle set. Attach the needle set to the HY syringe. *Slowly* push the plunger to fill the needle set. Stop when the HY reaches the needle hub. Lay the syringe down on the clean work surface. Clamp the needle set tubing. Label the syringe HY.

\*Use an 18-22 gauge sterile needle to draw from the 1.25 mL vial of HY.

†Re-cap the needle/needle-less transfer device with a one-handed scooping technique as demonstrated by your healthcare professional.

You're ready for **Stage 3!**

2 PREPARE HY

3 PREPARE IG

4 INFUSE HYQVIA

5 FINISH UP

# STAGE 3

## Prepare the IG

- Draw IG into syringe(s)



### Important Safety Information (continued)

**What are the possible or reasonably likely side effects of HYQVIA?**

**HYQVIA can cause serious side effects. If any of the following problems occur after starting HYQVIA, stop the infusion immediately and contact your HCP or call emergency services:**

- Hives, swelling in the mouth or throat, itching, trouble breathing, wheezing, fainting or dizziness. These could be signs of a serious allergic reaction.
- Bad headache with nausea, vomiting, stiff neck, fever, and sensitivity to light. These could be signs of irritation and swelling of the lining around your brain.
- Reduced urination, sudden weight gain, or swelling in your legs. These could be signs of a kidney problem.

***Please scroll for additional Important Safety Information, and click for [Information for Patients](#), including Warning about Blood Clots, and discuss with your healthcare provider.***

**HyQvia**

[Immune Globulin Infusion 10% (Human)  
with Recombinant Human Hyaluronidase]

# HyQvia

[Immune Globulin Infusion 10% (Human)  
with Recombinant Human Hyaluronidase]



Without shaking the vials, clean each vial of IG you will use by wiping the stopper with an alcohol swab and let it dry.

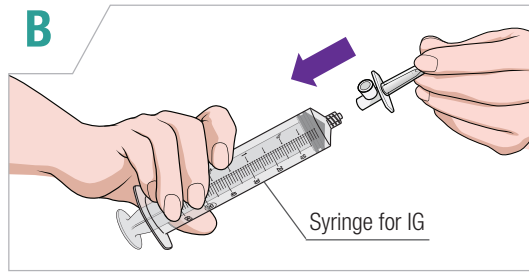

Open a larger (60 mL) sterile syringe. Attach the larger sterile syringe to a vented spike. Remove the cap from the spike and discard it in the trash.

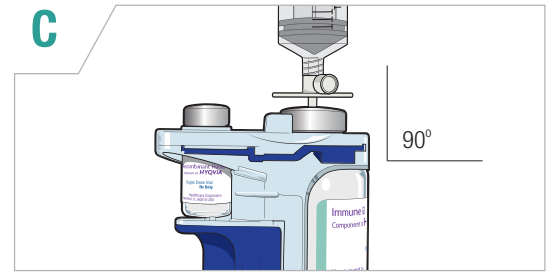

Insert the vented spike straight down into the center of the IG vial stopper.

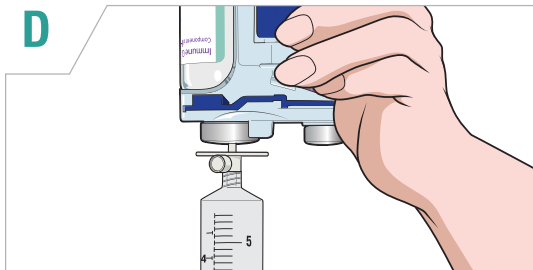

Turn the vial upside down and pull on the plunger to withdraw the desired dose of IG. When the syringe is full or you have reached your dose, turn the vial right side up and remove the syringe from the spike. Leave the spike in the vial. (You'll leave the spike in the vial each time.)

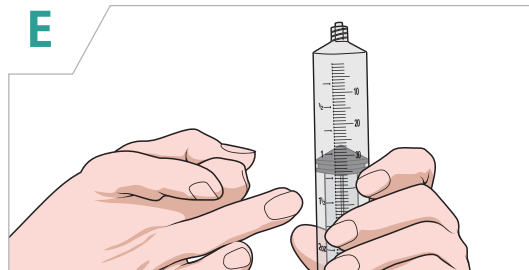

Tap the syringe to remove bubbles. Slowly push the plunger until medication is at the tip of the barrel. Cover the syringe with the sterile tip cap.

If the full dose of IG hasn't been drawn up and there is still fluid in the vial, or if the full dose requires multiple vials of IG, repeat steps A through E.

**STAGE 3 CONTINUED**

4 INFUSE HYQVIA

5 FINISH UP

3 PREPARE IG

# STAGE 4

## Infuse HYQVIA

- Insert and secure needle(s)
- Infuse HY manually (first)
- Infuse IG with pump (second)

### Important Safety Information (continued)

**What are the possible or reasonably likely side effects of HYQVIA? (continued)**

**HYQVIA can cause serious side effects. If any of the following problems occur after starting HYQVIA, stop the infusion immediately and contact your HCP or call emergency services:**

- Pain, swelling, warmth, redness, or a lump in your legs or arms, other than at the infusion site(s). These could be signs of a blood clot.
- Brown or red urine, fast heart rate, yellow skin or eyes. These could be signs of a liver or blood problem.
- Chest pain or trouble breathing, blue lips or extremities. These could be signs of a serious heart or lung problem.
- Fever over 100°F. This could be a sign of an infection.

***Please scroll for additional Important Safety Information, and click for [Information for Patients](#), and discuss with your healthcare provider.***

**HyQvia**

**[Immune Globulin Infusion 10% (Human)  
with Recombinant Human Hyaluronidase]**

# HyQvia

[Immune Globulin Infusion 10% (Human)  
with Recombinant Human Hyaluronidase]

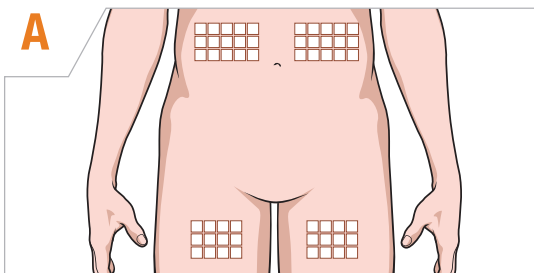

Choose an infusion site (or sites) in either the middle or upper abdomen or thigh. Avoid bony areas, visible blood vessels, scars, and any areas of inflammation, irritation, or infection. Rotate your sites by choosing opposite sides of the body for each infusion.

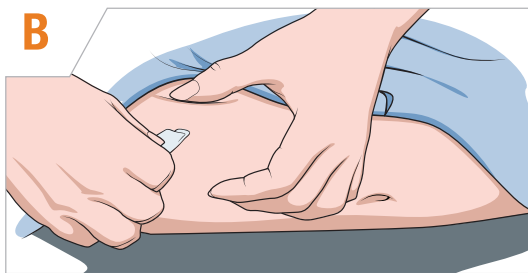

Wash your hands with antibacterial soap. Wipe each infusion site with a sterile alcohol wipe (beginning at the center of the site and moving outward in a circular motion) and let dry (at least 30 seconds).

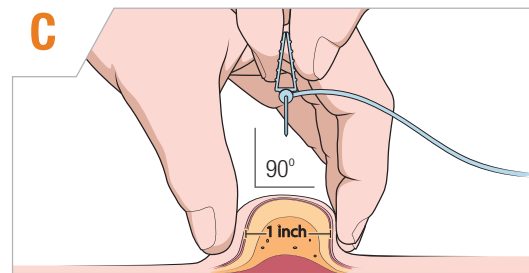

Remove the subcutaneous needle cover. Firmly grasp and pinch at least 1 inch of skin. Insert the needle with a rapid motion straight into the skin at a 90-degree angle. Secure the needle in place with sterile tape. Repeat this step for additional infusion sites.

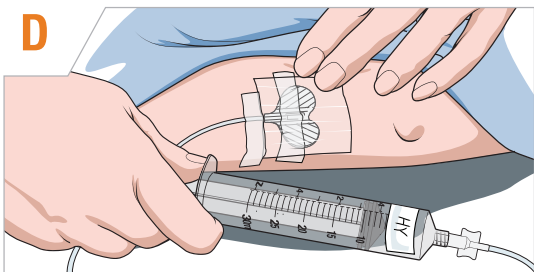

Check for proper needle placement. Open the clamp on the needle set and gently pull back on the syringe plunger. Make sure there is no blood in the tubing. Secure the needle set in place by applying a clear dressing over the site. If blood is seen in the tubing, remove and discard the subcutaneous needle and repeat steps 2A-2F and 4A-4C with a new needle and infusion site.

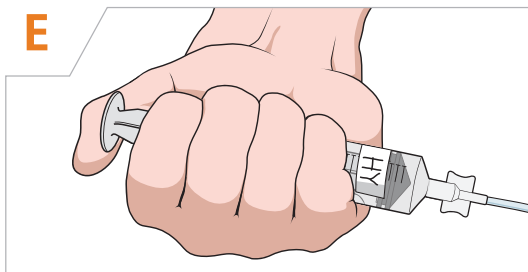

Administer the HY at a rate of 1 to 2 mL per minute per infusion site. (For example, infusing 15 mL of HY should take about 7.5 to 15 minutes for a 30 gram HYQVIA dose.) Divide content equally between sites, if more than one site is used. **REMEMBER: HY before IG.**

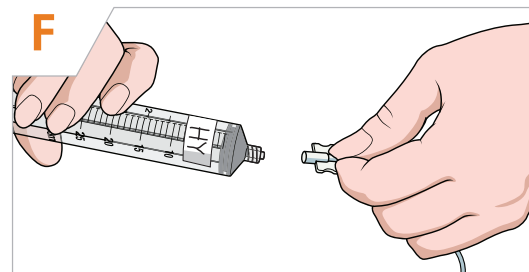

When all the HY has been infused, detach the syringe from the subcutaneous needle set. Do not remove the needle(s) from your infusion site(s).

STAGE 4 CONTINUED

5 FINISH UP

# STAGE 4

## Infuse HYQVIA (*continued*)

- Insert and secure needle(s)
- Infuse HY manually (first)
- Infuse IG with pump (second)

### **Important Safety Information (continued)** **What are the possible or reasonably likely side effects of HYQVIA? (continued)**

After HYQVIA infusion a temporary, soft swelling may occur around the infusion site, which may last 1 to 3 days, due to the volume of fluid infused. The following possible side effects may occur at the site of infusion and generally go away within a few hours, and are less likely after the first few infusions.

- Mild or moderate pain
- Swelling
- Redness
- Itching

The most common side effects of HYQVIA are:

- Headache
- Fever
- Fatigue
- Vomiting
- Nausea

***Please scroll for additional Important Safety Information, and click for [Information for Patients](#), including Warning about Blood Clots, and discuss with your healthcare provider.***

**HyQvia**  
[Immune Globulin Infusion 10% (Human)  
with Recombinant Human Hyaluronidase]



# HyQvia

[Immune Globulin Infusion 10% (Human)  
with Recombinant Human Hyaluronidase]

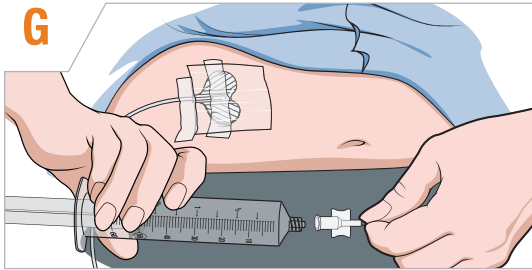

**G** Remove the sterile tip cap from the larger (60 mL) IG syringe and attach it to the same needle set.

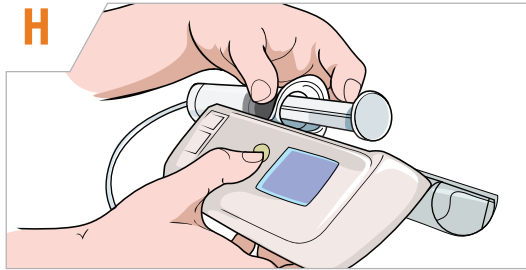

**H** Insert the IG syringe into the pump and start the pump at the rates prescribed by your healthcare professional. Start the IG infusion **right after** the HY infusion is complete (approximately within 10 minutes).

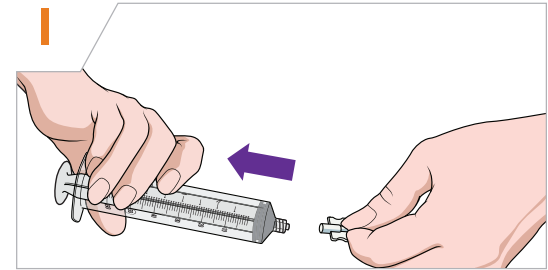

**I** When the IG syringe is empty, remove the syringe from the pump and detach it from the needle set. Repeat steps G through I for each additional syringe of IG.

You're almost done! >>>

4 INFUSE HYQVIA

5 FINISH UP

# STAGE 5

## Finish Up

- Remove needle(s)
- Log infusion



### **Important Safety Information (continued)**

#### **What are the possible or reasonably likely side effects of HYQVIA? (continued)**

Antibodies to the hyaluronidase component of HYQVIA were formed in some patients taking HYQVIA. It is not known if there is any long-term effect. In theory, these antibodies could react with your body's own hyaluronidase (PH20). PH20 is present in the male reproductive tract. So far, these antibodies have not been associated with increased or new side-effects.

**These are not all the possible side effects. Talk to your HCP about any side effect that bothers you or that does not go away.**

**You are encouraged to report negative side effects of prescription drugs to the FDA. Visit [www.fda.gov/medwatch](http://www.fda.gov/medwatch), or call 1-800-FDA-1088.**

*Please scroll for additional Important Safety Information, and click for [Information for Patients](#), including [Warning about Blood Clots](#), and discuss with your healthcare provider.*

**HyQvia**

[Immune Globulin Infusion 10% (Human)  
with Recombinant Human Hyaluronidase]

# HyQvia

[Immune Globulin Infusion 10% (Human)  
with Recombinant Human Hyaluronidase]

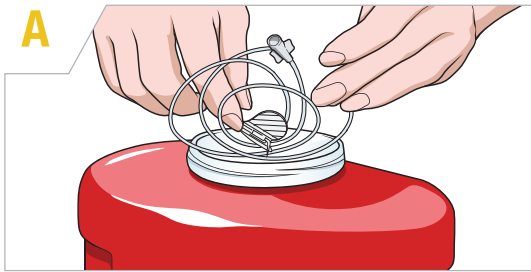

Loosen the clear dressing and pull the subcutaneous needle wings straight up and out. Place a bandage over the site. Dispose of the needle set in the sharps container. Check with your specialty pharmacy to learn how to dispose of your sharps container.



Record the infusion details as instructed by your healthcare professional and as outlined in your infusion log.



Follow up with your healthcare professional as directed.

## Congratulations!

Your infusion with **HYQVIA**  
[Immune Globulin Infusion 10% (Human) with  
Recombinant Human Hyaluronidase] Solution is complete!

If you have any questions about infusing HYQVIA, contact a Nurse Advocate at 1-855-250-5111 or your healthcare provider, or visit [www.HYQVIA.com](http://www.HYQVIA.com)



*HyQvia*

[Immune Globulin Infusion 10% (Human)  
with Recombinant Human Hyaluronidase]

**HyQvia**

[Immune Globulin Infusion 10% (Human)  
with Recombinant Human Hyaluronidase]

## WHAT IT LOOKS LIKE WHEN YOU INFUSE HYQVIA

### What to expect

#### Pre-Infusion



HYQVIA Infused: 500 mL

#### Post-Infusion



#### 24 Hours After Infusion



Following your infusion with HYQVIA [Immune Globulin Infusion 10% (Human) with Recombinant Human Hyaluronidase] Solution, it's common to experience a temporary soft swelling at the infusion site. This is due to the volume of fluid infused and may last 1 to 3 days after your infusion. The volume you'll infuse will be based on your doctor's guidance and your specific clinical condition; it may be different from the volumes shown here.



HYQVIA Infused: 235 mL



### Mild local site reactions

Local infusion-site reactions such as mild or moderate pain, swelling, redness, and itching may also occur and generally go away within a few hours. Local reactions are less likely to occur after the first few infusions.

#### Pre-Infusion



HYQVIA Infused: 494 mL

#### Post-Infusion





**HyQvia**

[Immune Globulin Infusion 10% (Human)  
with Recombinant Human Hyaluronidase]

## What to Do If You Experience a Local Reaction

After HYQVIA infusion a temporary, soft swelling may occur around the infusion site, which may last 1 to 3 days, due to the volume of fluid infused. Mild or moderate pain, redness, swelling, or itching may occur at the site of infusion and generally go away in a few hours. Local reactions are less likely after the first few infusions. Contact your healthcare professional if a local site reaction increases in severity or persists for more than a few days.<sup>1,2</sup>

### Discomfort or pain at the infusion site when inserting the subcutaneous needle

- Remove the needle because it may be in your muscle.<sup>3</sup>
- Contact your healthcare professional if severe pain does not fade when you remove the needle or if it happens each time you infuse.
- Talk to your healthcare professional or specialty pharmacy about changing the length of your needle; it may be too long for you.<sup>2</sup>
- Note in your infusion log that this site may not work for you.

### Discomfort, pain, or redness at the infusion site during or after your infusion

- Slow or stop the infusion.<sup>3</sup>
- Place a clean, warm or cold compress (post-infusion) as directed by your healthcare professional on your irritated site.<sup>2,3</sup>
- Talk to your healthcare professional about a possible allergy to your tape or dressing or the possible use of a mild pain reliever, if recommended.<sup>2,3</sup>

### Itching or rash at or around the infusion site

- Place a clean, cold compress as directed by your healthcare professional on your itchy site. Do not apply cold pack directly to skin.<sup>3</sup>
- When priming the subcutaneous needle, avoid coating the needle with drops of HYQVIA [Immune Globulin Infusion 10% (Human) with Recombinant Human Hyaluronidase] Solution.<sup>2,3</sup>
- Talk to your healthcare professional about the possible use of an over-the-counter antihistamine, if recommended.<sup>3</sup>
- If you experience hives, swelling in the mouth or throat, itching, trouble breathing, wheezing, fainting or dizziness, stop your infusion immediately and contact your healthcare professional or emergency services; these could be signs of a serious allergic reaction.<sup>3</sup>

## What to Do If You Experience a General (Systemic) Reaction

In addition to local reactions, the most common side effects of HYQVIA are headache, fatigue, nausea, fever, and vomiting.<sup>1</sup>

Call your healthcare professional or go to your emergency department right away if you get:

- Bad headache with nausea, vomiting, stiff neck, fever, and sensitivity to light. These could be signs of swelling in your brain.
- Reduced urination, sudden weight gain, or swelling in your legs. These could be signs of a kidney problem.
- Pain, swelling, warmth, redness, or a lump in your legs or arms, other than at the infusion site(s). These could be signs of a blood clot.
- Brown or red urine, fast heart rate, yellow skin or eyes. These could be signs of a liver or blood problem.
- Chest pain or trouble breathing, blue lips or extremities. These could be signs of a lung problem.

Talk to your healthcare professional about any side effects that bother you or that don't go away.<sup>1</sup>

Whenever giving yourself treatments at home, consider having another responsible person present to help treat side effects or get help if a serious adverse reaction occurs. Ask your healthcare professional whether you should have rescue medications, such as antihistamines or epinephrine available.<sup>3</sup>

**References:** **1.** HYQVIA [Prescribing Information]. Westlake Village, CA: Baxalta US Inc. **2.** Murphy E, Burton J, Riley P. Nursing approaches to a novel subcutaneous therapy: a look at 4 patients during transition from IVlg to SCIg. *Infusion*. 2007;13(4)(suppl):1-8. **3.** Younger MEM, ed. *IDF Guide for Nurses on Immune Globulin Therapy for Primary Immunodeficiency Diseases*. 3rd ed. Towson, MD: Immune Deficiency Foundation; 2012.

  
**[Immune Globulin Infusion 10% (Human)  
with Recombinant Human Hyaluronidase]**

## What is HYQVIA?

HYQVIA is a liquid medicine that is given under the skin (subcutaneously) to treat primary immunodeficiency (PI) in people 2 years and older.

## Important Safety Information

### What is the most important information that I should know about HYQVIA?

- HYQVIA can cause blood clots.
- Call your healthcare professional (HCP) if you have pain, swelling, warmth, redness, or a lump in your legs or arms, other than at the infusion site(s), unexplained shortness of breath, chest pain or discomfort that worsens on deep breathing, unexplained rapid pulse, numbness or weakness on one side of the body.
- Your HCP may perform blood tests regularly to check your IgG level.
- Do not infuse HYQVIA into or around an infected or red swollen area because it can cause infection to spread.

### Who should not take HYQVIA?

Do not take HYQVIA if you:

- Are allergic to IgG, hyaluronidase, other blood products, or any ingredient in HYQVIA.

### What should I avoid while taking HYQVIA?

- HYQVIA can make vaccines (like measles/mumps/rubella or chickenpox vaccines) not work as well for you. Before you get any vaccines, tell your HCP that you take HYQVIA.

### What should I tell my HCP before I start using or while using HYQVIA?

Tell your HCP if you:

- Have or had any kidney, liver, or heart problems or history of blood clots because HYQVIA can make these problems worse.
- Have IgA deficiency or a history of severe allergic reactions to IgG or other blood products.
- Are pregnant, trying to become pregnant or are breast feeding. It is not known whether HYQVIA can harm the unborn baby or breastfed infant.

### What are the possible or reasonably likely side effects of HYQVIA?

**HYQVIA can cause serious side effects. If any of the following problems occur after starting HYQVIA, stop the infusion immediately and contact your HCP or call emergency services:**

- Hives, swelling in the mouth or throat, itching, trouble breathing, wheezing, fainting or dizziness. These could be signs of a serious allergic reaction.



[Immune Globulin Infusion 10% (Human)  
with Recombinant Human Hyaluronidase]

## Important Safety Information (continued)

### What are the possible or reasonably likely side effects of HYQVIA? (continued)

- Bad headache with nausea, vomiting, stiff neck, fever, and sensitivity to light. These could be signs of irritation and swelling of the lining around your brain.
- Reduced urination, sudden weight gain, or swelling in your legs. These could be signs of a kidney problem.
- Pain, swelling, warmth, redness, or a lump in your legs or arms, other than at the infusion site(s). These could be signs of a blood clot.
- Brown or red urine, fast heart rate, yellow skin or eyes. These could be signs of a liver or blood problem.
- Chest pain or trouble breathing, blue lips or extremities. These could be signs of a serious heart or lung problem.
- Fever over 100°F. This could be a sign of an infection.

After HYQVIA infusion a temporary, soft swelling may occur around the infusion site, which may last 1 to 3 days, due to the volume of fluid infused. The following possible side effects may occur at the site of infusion and generally go away within a few hours, and are less likely after the first few infusions.

- Mild or moderate pain
- Redness
- Swelling
- Itching

The most common side effects of HYQVIA are:

- Headache
- Fatigue
- Nausea
- Fever
- Vomiting

Antibodies to the hyaluronidase component of HYQVIA were formed in some patients taking HYQVIA. It is not known if there is any long-term effect. In theory, these antibodies could react with your body's own hyaluronidase (PH20). PH20 is present in the male reproductive tract. So far, these antibodies have not been associated with increased or new side-effects.

**These are not all the possible side effects. Talk to your HCP about any side effect that bothers you or that does not go away.**

**For additional Important Safety Information, click for [Information for Patients](#), and discuss with your HCP.**

**You are encouraged to report negative side effects of prescription drugs to the FDA. Visit [www.fda.gov/medwatch](http://www.fda.gov/medwatch), or call 1-800-FDA-1088.**



**HyQvia**

**[Immune Globulin Infusion 10% (Human)  
with Recombinant Human Hyaluronidase]**

©2023 Takeda Pharmaceuticals U.S.A., Inc., 300 Shire Way, Lexington, MA 02421. 1-877-TAKEDA-7 (1-877-825-3327).  
All rights reserved. TAKEDA® and the TAKEDA Logo® are registered trademarks of Takeda Pharmaceutical Company  
Limited. HYQVIA® is a registered trademark of Baxalta Incorporated. US-HYQ-0719v1.0 05/23

